

ES1932

ELECTRIC SCISSOR LIFT

SCISSOR LIFT



KEY SPECS

Platform Height
19-ft / 5.8-m

Platform Capacity
507-lb / 230-kg

Number of Occupants
Indoor: 2
Outdoor: 1

Stowed Drive Speed
3.0 mph / 4.8 km/h

KEY FEATURES

- Refreshed design delivers electric drive, for up to double the battery life of a standard scissor.
- Our standard QuikFold rail system allows operators to fold the rails in a fraction of the time of a standard machine.
- Features a standard USB charger and phone holster, improving the operator experience while delivering a high degree of commonality with other JLG® scissors to simplify service.
- Available as an indoor-only option (ES1932i)

ACCESSORIES & OPTIONS

- 4 x 6V AGM Batteries, 220 ah
- 900W Inverter
- Anti-Vandalism PKG
- CleanGuard® Leak Containment
- Coiled Platform Control Box Cable
- Drive Motor Covers
- Dual Flashing Amber Beacons - LED
- MDI (Ground)
- Panel Carrier
- Pipe Racks
- QuikAccess Platform
- SkySense® Enhanced Detection System
- White Noise Alarm

STANDARD SPECIFICATIONS

Performance	Indoor	Outdoor
Platform Height (Elevated)	19-ft / 5.8-m	19-ft / 5.8-m
Platform Capacity	507-lb / 230-kg	507-lb / 230-kg
Capacity on Platform Extension	265-lb / 120-kg	265-lb / 120-kg
Number of Occupants	2	1
Lift / Lower Time (No Load)	20/27 seconds	20/27 seconds
Lift / Lower Time (Rated Load)	25/26 seconds	25/26 seconds
Maximum Drive Height	Fully Elevated	Fully Elevated
Weight*	3,450-lb / 1,565-kg	3,450-lb / 1,565-kg
Max. Ground Bearing Pressure	117 psi / 8.23 kg/cm ²	117 psi / 8.23 kg/cm ²
Drive Speed (Lowered)	3.0 mph / 4.8 km/h	3.0 mph / 4.8 km/h
Drive Speed (Raised)	0.5 mph / 0.8 km/h	0.5 mph / 0.8 km/h
Gradeability	25%	25%
Max Tilt Rating (Side-to-Side)	1.75 Degrees	1.5 Degrees
Max Tilt Rating (Fore and Aft)	3.75 Degrees	3.75 Degrees
Turning Radius (Inside)	Zero	Zero
Turning Radius (Outside)	66-in / 1.7-m	66-in / 1.7-m

*Certain options or country standards increase weight

Power

Batteries	4 x 6V 220 amp-hr
Charger	27 Amp
Drive	24V DC

Tires

Standard	12.7 x 4-in / 323 x 102-mm
----------	----------------------------

Brakes

Multi-Disc Friction

Hydraulic System

Capacity	1.85 gal / 7 L
Pump	Fixed Displacement Gear

STANDARD FEATURES

- 27 amp Multi-Function Universal Charger
- AC Receptacle in Platform
- Active Pothole Protection System
- All Motion Alarm
- Analyzer Port for Diagnostics
- Battery Condition Indicator
- CAN-Enabled Charger
- ClearSky Smart Fleet™ Hardware (CS550)**
- Diamond Tread Steel Deck
- Dynamic Braking
- Electric Drive
- Foot-Actuated Deck Extension
- Fork Lift Pockets
- Greaseless Kingpin Joints
- Horn
- Hourmeter
- Lanyard Attach Points
- LED Motion/Amber Beacon (CS550)**
- Lifting and Tie Down Points
- Load Sensing System
- Lubrication Free Scissor Arm Bushings
- Manual Descent Cable
- Movable, Removable Platform Control
- Nickel Plated Pins
- Proportional Controls
- QuikFold Rails
- Removable Ladder
- Scissor Maintenance Prop
- Self-Closing Gate
- Steel Swing-Out Doors
- Tilt Alarm and Light
- USB Charger & Phone Holder
- Variable Tilt Visual Zone Indicator

**Standard beacon and ClearSky Smart Fleet hardware availability varies by model throughout 2023.

ES1932

ELECTRIC SCISSOR LIFT

SCISSOR LIFT



DIMENSIONS

All dimensions are approximate

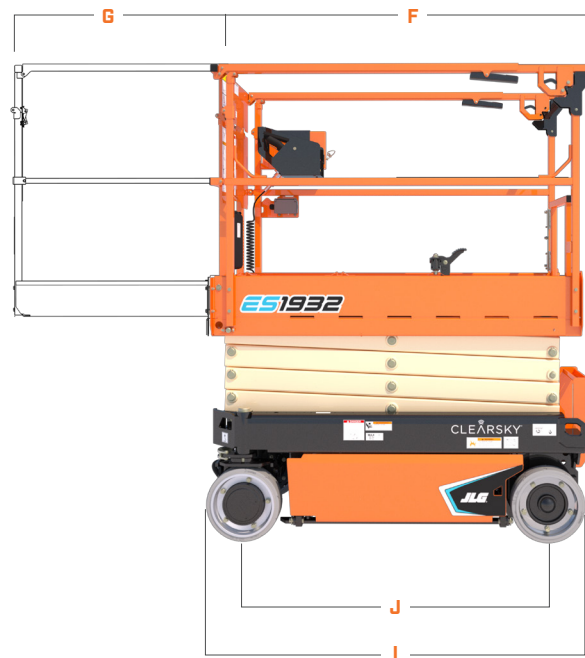
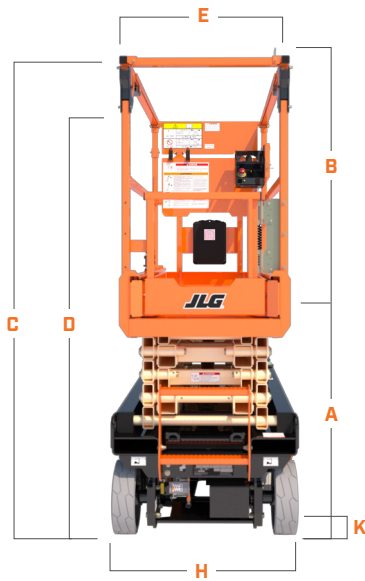

A. Platform Height (Lowered)	38.6-in / 1.0-m
B. Platform Railing Height	44.4-in / 1.13-m
C. Machine Height (Rails Raised)	82.8-in / 2.1-m
D. Machine Height (Rails Lowered)	78.2-in / 1.99-m
E. Platform Width	25.4-in / .64-m
F. Platform Length	62.7-in / 1.59-m
G. Platform Extension	36-in / 91-cm

H. Machine Width	32-in / 81-cm
I. Machine Length	68.7-in / 1.7-m
J. Wheelbase	53-in / 1.3-m
K. Ground Clearance	2.8-in / 7-cm



We provide coverage for one (1) full year, and cover all specified major structural components for five (5) years. Due to continuous product improvements, we reserve the right to make specification and/or equipment changes without prior notification. This machine meets or exceeds applicable ANSI and CSA requirements based on machine configuration as originally manufactured for intended applications. Please reference the serial number plate on the machine for additional information.



JLG INDUSTRIES, INC.
Toll-free US 877-JLG-LIFT
JLG.com

An Oshkosh Corporation Company